COLOR TFT LCD MONITOR Manual



DEAR CUSTOMERS

Thank you for purchasing the liquid crystal display monitor. This product employs new integrate circuits and high quality TFT LCD modules. It is putting out with its low power consumption, emits no radiation, and other advantage characteristics. This product is shaped with modern style and is easy to be carried with. The color TFT LCD is the most suitable display for VGA,VCD, DVD and GPS system for motorcars and ships .It also can be used in the office ,in flat ,at home also in other suitable position. You will certainly benefit from this monitor in lots of ways, for example, convenience, safety, space-saving.

We hope that you will have the enjoyment of your new mini color TFT LCD.

To ensure the best use of the unit, please read this handbook carefully beforehand.

CAUTION

1. Please use the adapter attached in the accessory.
2. Do not expose this product to direct sunlight, heat or humid conditions.
3. Keep away from strong light while using this product so as to obtain the clearest and the most colorful picture.
4. Please avoid heavy impact or drop onto the ground.
5. Do not use chemical solutions to clean this unit. Please simply wipe with a clean soft cloth to keep the brightness of the surface.
6. If the product does not operate normally when the instructions are followed. Adjust only those controls that are covered by the instructions. Improper adjustment of other controls may result in damage and will often require extensive work of a qualified technician.

Please unplug the power if non-use for a long-term, or a thunder and happens.

CONTENTS

1. PRODUCT DESCRIPTION	-----
2. REMOTE CONTROLLER	-----
3. MATCHED CABLES	-----
4. MENU OPERATION	-----
IN AV MODE	-----
IN PC MODE	-----
IN DVI&HDMI MODE	-----
5. RAIL SLOT	-----
6. ACCESSORIES	-----
7. PARAMETER	-----
8. TROUBLESHOOTING	-----
9. REMARK	-----

1.PRODUCT DESCRIPTION



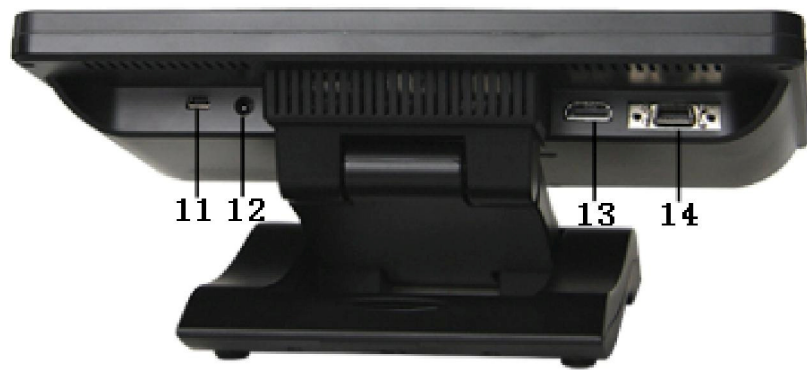

1. AV/PC : PC、DVI、VIDEO1、VIDEO2、HDMI switch
2. + : Volume up or to adjust the value of menu setting function
3. - : Volume down or to adjust the value of menu setting function
4. ▲ : To select function on OSD or to adjust the brightness directly under 6 classes
5. ▼ : to select item on the OSD or push the key in PC mode directly to adjust phase automatically
6. MENU: To activate OSD menu

(PS: Long press "MENU" button to zoom in or out picture)

automatically when receiving HDMI signal.)

7. Indicate light
8. Infrared receiving window
9. POWER : Power on/off
10. USB interface (connection HUB: Optional)
11. Mini USB interface (Optional)
12. Power input
13. DVI、 HDMI input interface
14. 14P SKS input interface
15. Mounting Process: Standard VESA Sockets (75mm)

2.REMOTECONTROLLER

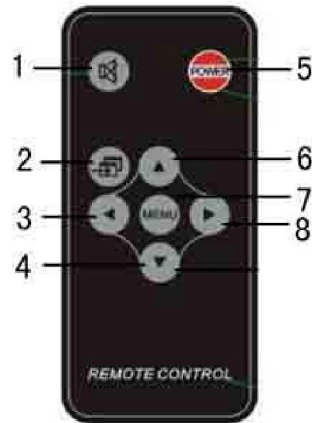

1. MUTE

2. Display switch: PC、 DVI、 VIDEO1、 VIDEO2、 HDMI switch

3. ◀: Left move, Volume down or to adjust the value of setting function

4. ▼: Down move, to select function on OSD

5. POWER ON/OFF

6. ▲: UP move, To select function on OSD

7. MENU

8. ▶: Right move, Volume up or to adjust the value of setting function

3.MATCHED CABLES

Match cable

SKS cable:



1. 14P SKS Input Jack: all kinds of AV signal input, note that put it correctly into the SKS input jack of the monitor
2. Black 9-pin VGA signal input jack
3. Yellow RCA: Video signal 1 input
4. Yellow RCA: Video signal 2 input
5. White RCA: Audio signal input
6. Black Jack: DC 12V Power input

VGA cable



1. Black 9-pin VGA connector, contact to the 9-pin VGA signal input jack of SKS cable.
2. USB end connect the USB port of computer for touch screen function.
3. 15-pin VGA signal input end connect VGA port of the computer.

HDMI to DVI cable:



1. HDMI signal input end
2. DVI signal input connect with device with DVI signal
3. USB connect with the USB port of computer for touch function (Optional)

HDMI to HDMI cable:



1. HDMI signal input end
2. HDMI signal input connect device with HDMI signal
3. USB port connect computer for touch function (Optional)

4.MENUOPERATION

After connected correctly and then Power on, Press “MENU” on the unit or by remote control to show MENU.

IN AV MODE

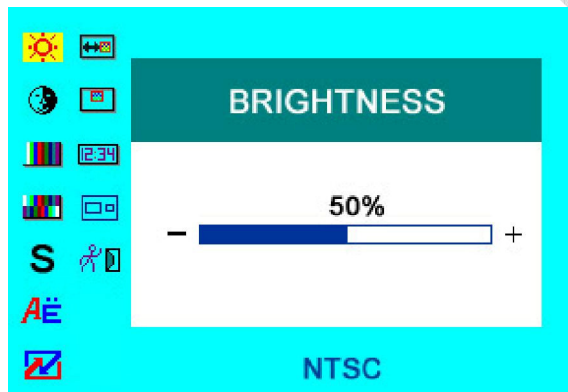

Press “▲ / ▼” on the unit or “▲ / ▼” on the remote control to select item, eg.

, and it will be highlighted; and then press “+ / -” on the unit or “◀ / ▶” on the remote control to adjust the favorite values. It shows current picture format (NTSC&PAL) below the dialog box.

 BRIGHTNESS: to adjust the luminance of brightness

 CONTRAST: to adjust the level of contrast

 SATURATION: to adjust the level of saturation

 TINT: to adjust the hue of image

S SHARPNESS: to adjust the level of sharpness

A LANGUAGE : There are 2 languages provided for choice, English and Chinese

 RESET: you can reset adjustment of the unit when click “YES”

 OSD H-POSITION ADJUSTMENT: to adjust the OSD move in horizontal direction

 OSD V-POSITION ADJUSTMENT: to adjust the OSD move in vertical direction

 OSD DURATION: to adjust the duration of OSD from 5-100 seconds

 Mode shift between 4:3 and 16:9

 EXIT OSD: select “YES” to exit

IN PC MODE:

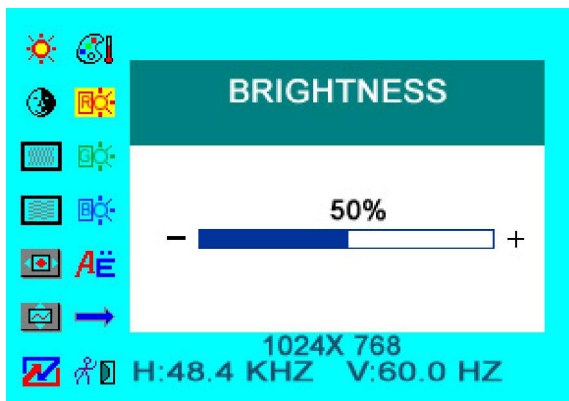



Press “▲ / ▼” on the unit or “▲ / ▼” on the remote control to select item, eg.

, and it will be highlighted; and then press “+ / -” on the unit or ◀ / ▶ on the remote control to adjust the favorite values. It shows current picture mode specifications below the dialog box.

 BRIGHTNESS: to adjust the luminance of brightness

 CONTRAST: to adjust the level of contrast

 PHASE: to adjust the beginning point and terminal point of image

 FREQUENCY: to adjust the frequency range of image



OSD H-POSITION: to adjust the picture position in horizontal direction





OSD V-POSITION: to adjust the picture position in vertical direction



RESET: you can reset adjustment of the unit when click “YES”



COLOR TEMPERATURE :choose color and temperature at first, such as: 6500⁰ K, 7500⁰ K or 9300⁰ K.

Only if under “USER” mode, can adjust  RED,  GREEN and  BLUE to meet the color value you need.



LANGUAGE : There are 2 languages provided for choice, English and Chinese



MISCELLANEOUS : to select  to enter next page

As follows:

OSD MISCELLANEOUS



OSD H-POSITION ADJUSTMENT: to adjust the OSD move in horizontal direction



OSD V-POSITION ADJUSTMENT: to adjust the OSD move in vertical direction



OSD DURATION: to adjust the duration of OSD from 5-100seconds.



OSD AUTO COLOR : If select “YES” it will adjust automatic color system to the best.



Mode shift between 4:3 and 16:9



EXIT OSD: select “YES” to exit

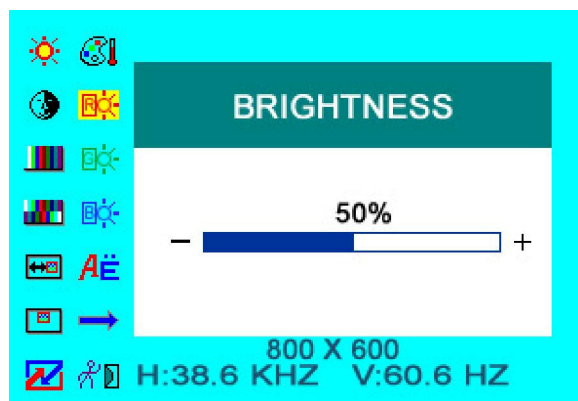

IN DVI & HDMI MODE

DVI MODE

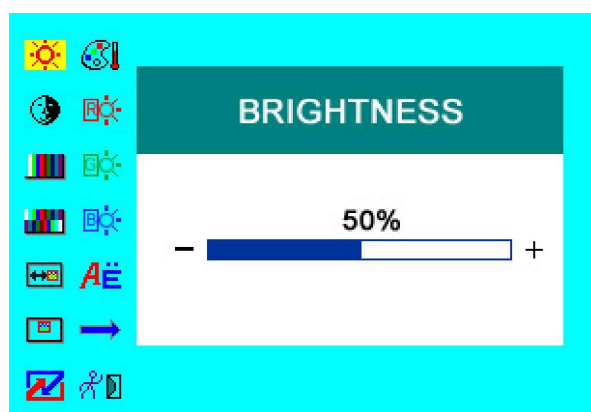

HDMI MODE



Press “▲ / ▼” on the unit or “▲/▼” on the remote control to select item, eg. , and it will be highlighted; and then press “+ / -” on the unit or  on the remote control to adjust the favorite values. It shows picture mode specifications below the dialog box in DVI mode, but not in HDMI mode.



BRIGHTNESS: to adjust the luminance of brightness



CONTRAST : to adjust the level of contrast



SATURATION: to adjust the level of saturation (this function doesn't work under DVI/HDMI mode)



TINT: to adjust the hue of image (this function doesn't work under DVI/HDMI mode)







OSD H-POSITION ADJUSTMENT: to adjust the OSD move in horizontal direction

 OSD V-POSITION ADJUSTMENT: to adjust the OSD move in vertical direction

 RESET: you can reset adjustment of the unit when click “YES”

 COLOR TEMPERATURE :choose color and temperature at first, such as: 6500⁰ K, 7500⁰ K or 9300⁰ K.

Only if under “USER” mode, can adjust  RED,  GREEN and  BLUE to meet the color value you need.

 LANGUAGE : There are 2 languages provided for choice, English and Chinese

 MISCELLANEOUS : to select  to enter next page of menu.

As follows:

OSD MISCELLANEOUS OF DVI MODE

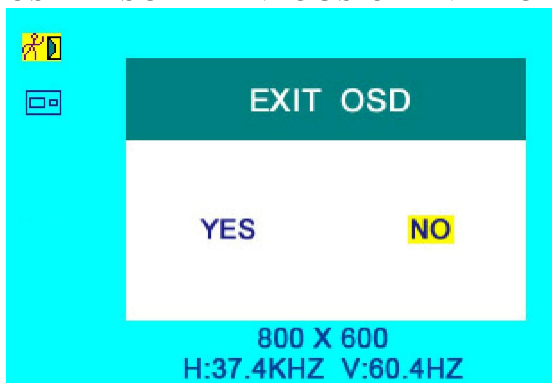

OSD MISCELLANEOUS OF HDMI MODE

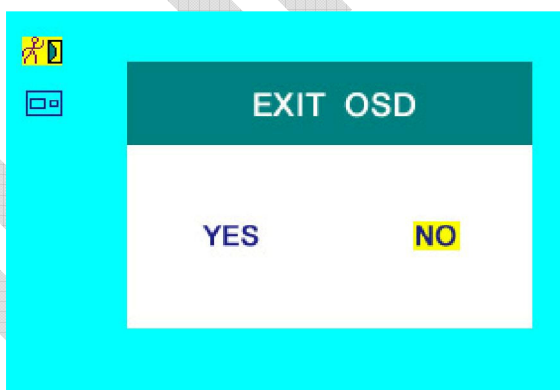

 Mode shift between 4:3 and 16:9

 EXIT OSD: select “YES” to exit

5.RAIL SLOT

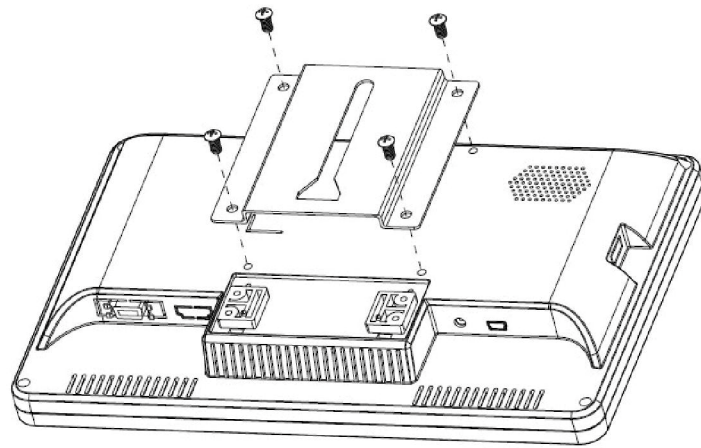

6.ACCESSORIES



1



2



3

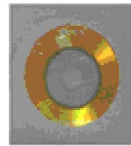

4



5



6



7



8



9



10

- | | |
|-------------------|--------|
| 1. Remote control | 1piece |
| 2. Manual | 1copy |
| 3. Touch pen | 1piece |
| 4. Drive disk | 1piece |

(touch driver, please choose and install correct touch driver as per your PC OS)

- | | |
|------------------------------------|--------|
| 5. DC adapter 12V | 1piece |
| 6. 14PIN SKS | 1Piece |
| 7. VGA cable | 1Piece |
| 8. HDMI to HDMI cable | 1piece |
| 9. HDMI to DVI cable | 1piece |
| 10. VESA 75mm rail slot (optional) | 1piece |

7.PARAMETER

Panel	10.1" LED (16:9)
Touch Function	Resistive touch panel
Resolution	1024×600
Brightness	250cd/m ²
Contrast	500:1
Viewing Angle	140°/ 110°(H/V)
Color System	PAL-4.43,NTSC-3.58
Input Voltage	DC 12V
Input Signal	AV1,AV2,PC(VGA), HDMI, DVI
Power Consumption	≤9W
Audio Output	≤1.2W
Mounting Process	Standard VESA Sockets (75mm)
Feature	4 or 5-wire resistive touch panel (FA1011)
	Multi-touch function (Windows 7 OS only!) (FA1012)
Dimension(LWD)	253.5×162.5×35/65.5mm (with bracket)
Weight	1166g

8.TROUBLE SHOOTING

1. Only black-and-white image

Check whether the level of color saturation and brightness is proper or not.

2. Power on but no picture

Make sure the PC、DVI、VIDEO、HDMI cable is tightly connected exactly correctly Make sure you are using the standard power adapter coming with the monitor.

3. Wrong or abnormal colors

If any color is missing, check the cables to make sure it is securely connected. Broken or loose pins in the cable connector can cause a bad connection.

4. Remote controller doesn't work

Check the battery to make sure the battery is installed properly and make sure it is not a low battery. The signal is interfered by some obstructions.

5. If any abnormal matters happened, pls enter "MENU" choose to reset

6. If it can't be touch, pls check the USB connect exactly correct or not, or install the correct touch driver as per the PC OS ?

9.REMARK:

If there are still any problems, you can connect with the related deals

*If interruptive image occurs, it maybe that the VGA signal frequency isn't matched with normal standard

*It is a normal condition that some bright lines appear on the screen when you turn the unit.

Note: due to constant effort to improve products and product features, specifications may change without notice.

LILLIPUT DIRECT