

# Field MONITOR

## User Manual



## **Important Safety Instructions:**

- Please read User Guide before using this product.
- Please keep User Guide for future reference.
- Please read the cautions to prevent possible danger and loss of property.

## **Contents**

<b>FEATURES.....</b>	<b>2</b>
<b>CAUTIONS .....</b>	<b>2</b>
<b>INITIAL SETUP .....</b>	<b>3</b>
<b>PRODUCT DESCRIPTION .....</b>	<b>4</b>
<b>INSTALLATION OF SUNSHADE.....</b>	<b>6</b>
<b>DV BATTERY MOUNT PLATE (OPTIONAL) .....</b>	<b>6</b>
<b>WIRING INSTRUCTIONS .....</b>	<b>7</b>
<b>MENU SETTING.....</b>	<b>8</b>
<b>PAPAMETERS.....</b>	<b>12</b>
<b>TROUBLE SHOOTING .....</b>	<b>12</b>

# FEATURES

- High resolution: 1280×800;
- High brightness: 400cd/m<sup>2</sup>;
- High contrast: 800:1;
- Built-in battery & battery level;
- HDMI & AV input;
- Foldable sun shade;

# CAUTIONS

- Please do not place the display screen towards the ground.
- Please avoid heavy impact or drop onto the ground.
- Please do NOT use chemical solutions to clean this product. Please wipe with a clean soft cloth to maintain the brightness of the surface.
- Please do not block any vent hole.
- Please follow the instructions and trouble-shootings to adjust the product. Other improper adjustment may result in damage. Any further adjustment must be performed or conducted by a qualified technician.
- Please unplug the power and remove the battery if long-term no-use, or thunder weather.

# INITIAL SETUP

## ❖ Unpacking

Carefully unpack the monitor and verify that the following items are included:

- Monitor
- Sun shade
- AV input cable
- AV output cable
- 12V DC adapter
- HDMI A/C cable
- Shoe mount
- 2600mAh built-in battery
- Manual



Inspect the unit for any physical damage that may have occurred during shipping. Should there be any damage, please immediately contact us.

## ❖ Optional Accessories

Additional accessory options for extra requirements. (Available at additional cost)

- VESA battery plate + Battery plate
- VESA folding bracket
- Mount plate bracket
- Anton Bauer / V-mount mount
- VESA rail slot
- Li-ion battery



**Tips: Recommend using our company's original accessories to prevent device from damage.**

# PRODUCT DESCRIPTION

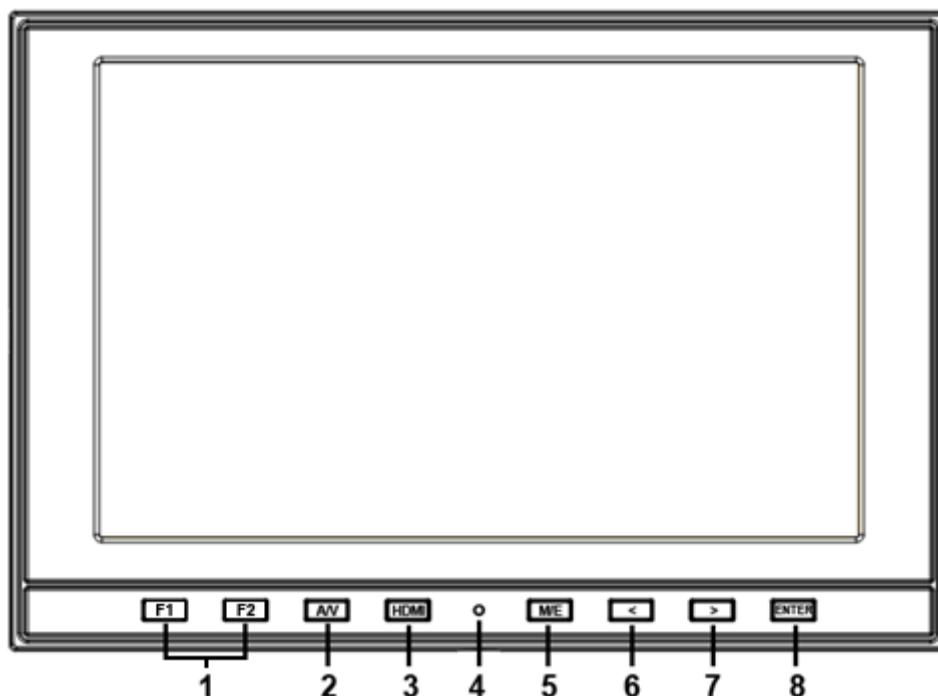

1. F1、 F2 User-definable buttons.
2. A/V: switch to AV state.
3. HDMI: switch to HDMI state.
4. Battery indicator  
**Status 1: the indicator light turns to fully red when battery charging.**  
**Status 2: the indicator light turns to half red when powered with DC power, but not with battery.**  
**Status 3: the indicator light turns to off when charge completely or use only with battery.**
5. M/E: to activate OSD (on-screen display) menu.  
**Select switch the brightness, contrast, saturation, Tint, sharpness, volume, MENU and Exit.**
6. < Left selection key, to select items on OSD menu and value option adjustment:  
**Press to adjust the brightness, contrast, saturation, Tint, sharpness and volume value decrease.**
7. > Right selection key, to select items on OSD menu, value option adjustment and confirmation:  
**Press to adjust the brightness, contrast, saturation, Tint, sharpness and volume value increase.**
8. ENTER.

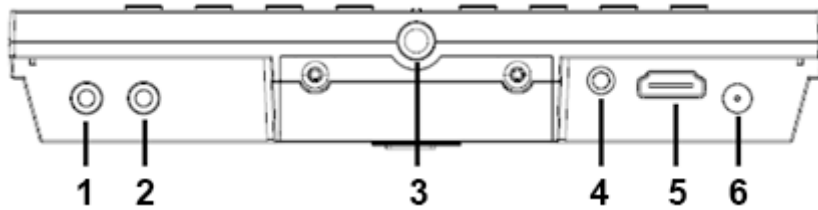

1. OUT: video output interface.
2. IN: video input interface.
3. Bracket mount (Depth limit 0.5cm).
4. Earphone jack.
5. HDMI input interface.
6. POWER: DC12V power input.

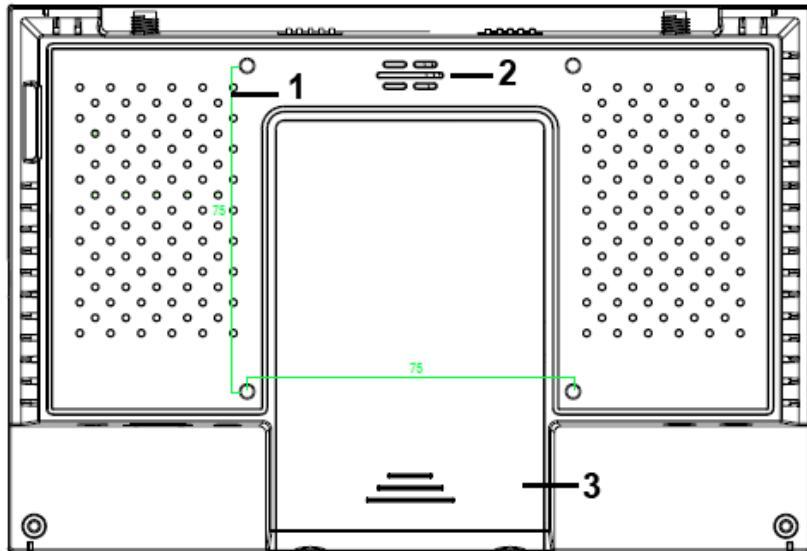

1. VESA mounting interface.
2. Speaker.
3. 2600mA battery slot (**built-in**).

## INSTALLATION OF SUNSHADE



## DV BATTERY MOUNT PLATE (OPTIONAL)

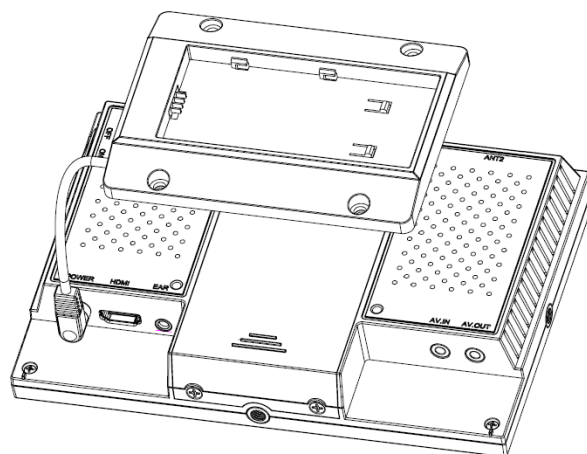

Following three types of battery plates are suitable for this device, model F970, QM91D, DU21 & LP-E6 (choose 2 out of 4).



MODEL: F-970



MODEL: QM91D

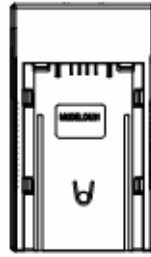

MODEL: DU21



MODEL: LP-E6

DV Battery Mount Plate:

### DV Battery Mount Plate Specification:

Model DU21 for battery of Panasonic DV:  
NV-GS/PV-GS/DZ-MV/GS/H28/H258/H288GK series, comply with  
Panasonic battery DU06/VBD140/SANYO DZhs301sw/Hitachi  
DZ-HS303SW/BZ-BP14S/DZ3200/BP07W.

Model QM91D for battery of SONY DV:  
DSCR1/F/S/MVCCD/E/HC15E/HC1E/AE1u/DCRTRV828/E/CCD-TRV  
116/DCR-DVD/PS105K/300K/10P/1E series.

Model F970 for battery of SONY DV:  
DCR-TRV series, DCR-TRV E series, VX2100E PD P series, GV-A700,  
GV-D800 FD/CCD-SC/TR3/FX1E/HVR-AIC, HDR-FX1000E, HVR-Z1C,  
HVR-V1C, FX7E F330.

Model LP-E6 for battery of Canon DSLR:  
5D Mark II/5D Mark III/EOS7D/EOS60D;

## WIRING INSTRUCTIONS

### ❖ Video Output Cable

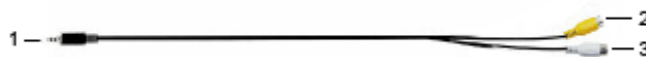

1. Video output interface.
2. Yellow: video 1 output plug.
3. White: video 2 output plug.



## ❖ Video Input Cable

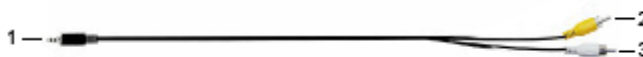

1. Video input interface.
2. Yellow: video 1 input plug.
3. White: video 2 input plug.

## MENU SETTING

Before setting the functions, please make sure the device is connected correctly.

### Shortcut keys

#### The image menu

When power on, press “< / >” key on the device, brightness will appear at the bottom of the screen, then press the MENU button to select brightness, contrast, saturation, Tint, sharpness, volume, MENU and Exit. User can adjust the parameters of the selected item with “< / >” button to meet their needs.



#### F1-F2 user-definable function buttons

Long press any F1-F2 key for 3-5 seconds to pop-up shortcut menu directly. As shown in Figure (default menu button in white font).

Use “< / >” buttons to select the desired option.

Finally, use the “ENTER” key to confirm the selected item as default.

Functions of F1-F3 buttons can also be customized: Center Marker, Safety Marker, Check Field, Color Bar, Aspect Ratio, Camera, Image Flip, Zoom, Pixel-to-Pixel, Freeze Input, Underscan, H/V delay.

Center Marker  
Safety Marker  
Check Field  
Color Bar  
Aspect Ratio  
Camera  
Image Flip  
Zoom  
Pixel-to-Pixel  
Freeze Input  
Underscan  
H/V delay

## Icon Display

Icons will display on screen when signal connected.

Select “Marker” on menu, and turn off “Battery Marker. And the icons will be invisible on screen.”

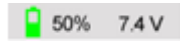

- Battery: battery level indicator.

## Menu Operation

When power on, press “MENU” on the device. The menu of function setting will display on the screen.

Press < / > buttons to choose menu; then press ENTER to confirm; after that, press MENU to return.

### PICTURE

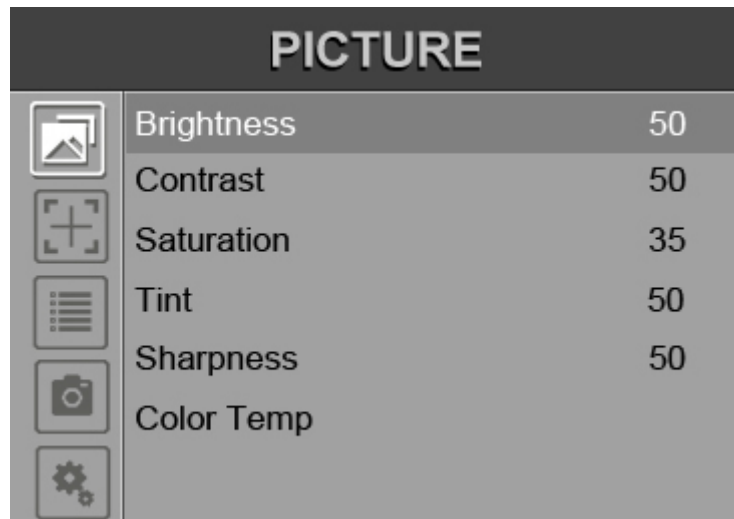

ITEMS	OPTIONS	
Brightness	0 – 100	
Contrast	0 – 100	
Saturation	0 – 100	
Tint	0 – 100	
Sharpness	0 – 100	
Color Temp	6500K, 7300K, 9300K, User	
	Color Temp R	Note: Available only under “User” mode to choose the color value you need.
	Color Temp G	
	Color Temp B	

## MARKER



\*Center marker and safe marker will be off automatically when battery marker is on.

ITEMS	OPTIONS
Center Marker	ON, OFF
Safety Marker	OFF, 95%, 93%, 90%, 88%, 85%, 80%
Battery Marker	ON, OFF

## DISPLAY

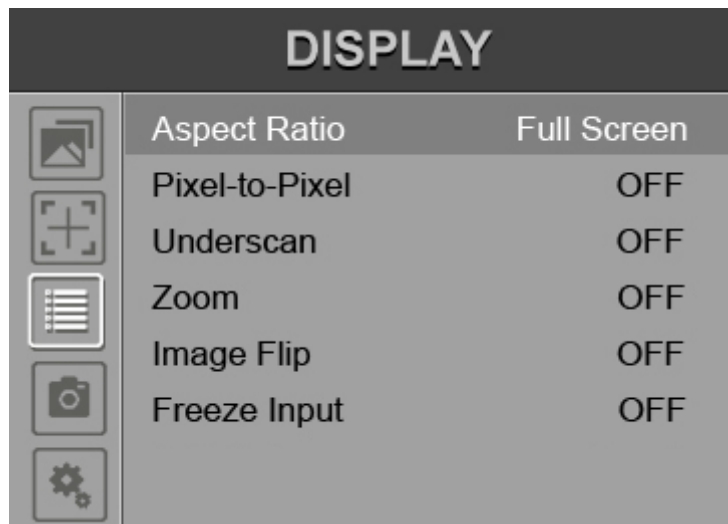

ITEMS	OPTIONS
Aspect Ratio	Full Screen, 4: 3, 16: 9, 1.85: 1, 2.35: 1
Pixel-to-Pixel	ON, OFF
Underscan	ON, OFF
Zoom	OFF, ×2, ×4, ×6, ×8
Image Flip	OFF, H, V, H / V
Freeze Input	ON, OFF

## DSLR AUX & AUDIO

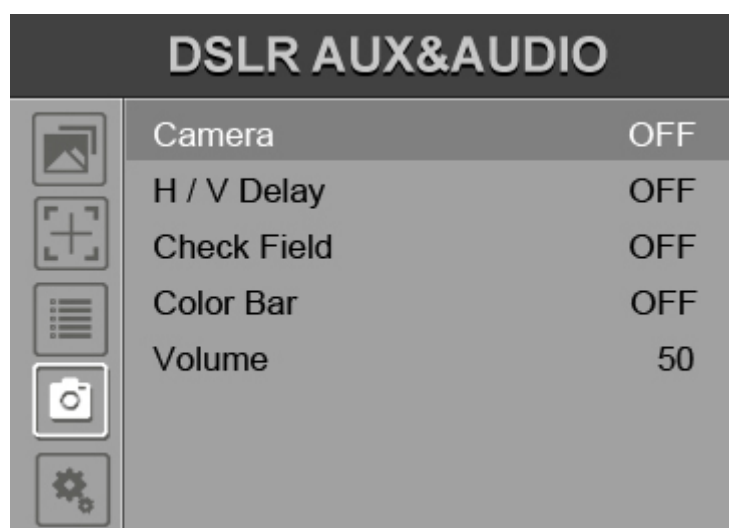

ITEMS	OPTIONS
Camera	ON, OFF ( Only HDMI mode)
H / V Delay	OFF, H&V, V, H
Check Field	OFF, Mono, Red, Green, Blue
Color Bar	ON, OFF
Volume	0 – 100

## SYSTEM

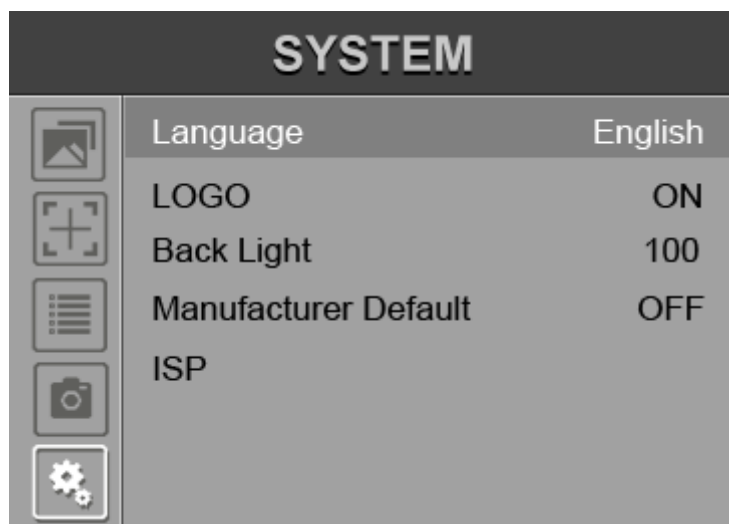

ITEMS	OPTIONS
Language	English, Chinese
LOGO	ON, OFF
Back Light	0 – 100
Manufacture Default	ON, OFF
ISP	

# PAPAMETERS

<b>Panel</b>	7" LED Backlit ( IPS )
<b>Physical Resolution</b>	1280×800
<b>Brightness</b>	400cd/m <sup>2</sup>
<b>Contrast</b>	800:1
<b>Viewing Angle</b>	178°/178° (H/V)
<b>Input Voltage</b>	DC 7~24V
<b>Aspect Ratio</b>	16:9
<b>Current</b>	580mA
<b>Power Consumption</b>	≤7W
<b>Operating Temperature</b>	-20°C~ 60°C
<b>Storage Temperature</b>	-30°C~ 70°C
<b>Dimension (LWD)</b>	185×126×30 (mm)
<b>Weight</b>	360g

## TROUBLE SHOOTING

### 1. Only black-and-white display

Check whether the brightness or color saturation is properly setup or not.

### 2. No image

Check the power input and connection

### 3. When on the picture shows size error

Press “MENU → DISPLAY → Underscan” to zoom in/out pictures automatically when receiving HDMI signals

### 4. Other problems

Please choose “MENU→SYSTEM→ Manufacturer Default →ON”

**Note: due to constant effort to improve products and product features, specifications may change without notice.**

