LCD Field Monitor

User Manual



IMPORTANT SAFETY INSTRUCTIONS:

- Please read manual before using this product.
- Please keep manual for future reference.
- Please read the cautions to prevent possible danger and loss of property.
- Please enjoy the benefits of convenience, safety, and space-saving from this TFT LCD monitor in different ways.

FEATURES:

- Metal shell;
- Wide viewing angles;
- Wide voltage: DC 7-24V;
- High brightness: 400cd/m²;
- High contrast: 800:1;
- TALLY interface with indicating light;
- Faster response time;
- Firm & portable design;
- Long F1~F4 keep press to POP-UP shortcut menu.

CAUTIONS:

1. Please do not place the display screen towards the ground.
2. Please avoid heavy impact or drop onto the ground.
3. Please do NOT use chemical solutions to clean this product. Please wipe with a clean soft cloth to maintain the brightness of the surface.
4. Please do not block any vent hole.
5. Please follow the instructions and trouble-shootings to adjust the product. Other improper adjustment may result in damage. Any further adjustment must be performed or conducted by a qualified technician.
6. Please unplug the power and remove the battery if long-term no-use, or thunder weather.

Contents

PRODUCT DESCRIPTION -----

INSTALLATION OF SUNSHADE COVER

AND BATTERY PLATE-----

DV BATTERY MOUNT PLATE-----

WIRING INSTRUCTIONS-----

SETTING MENU -----

ACCESSORIES -----

PARAMETER -----

TROUBLESHOOTING -----

PRODUCT DESCRIPTION

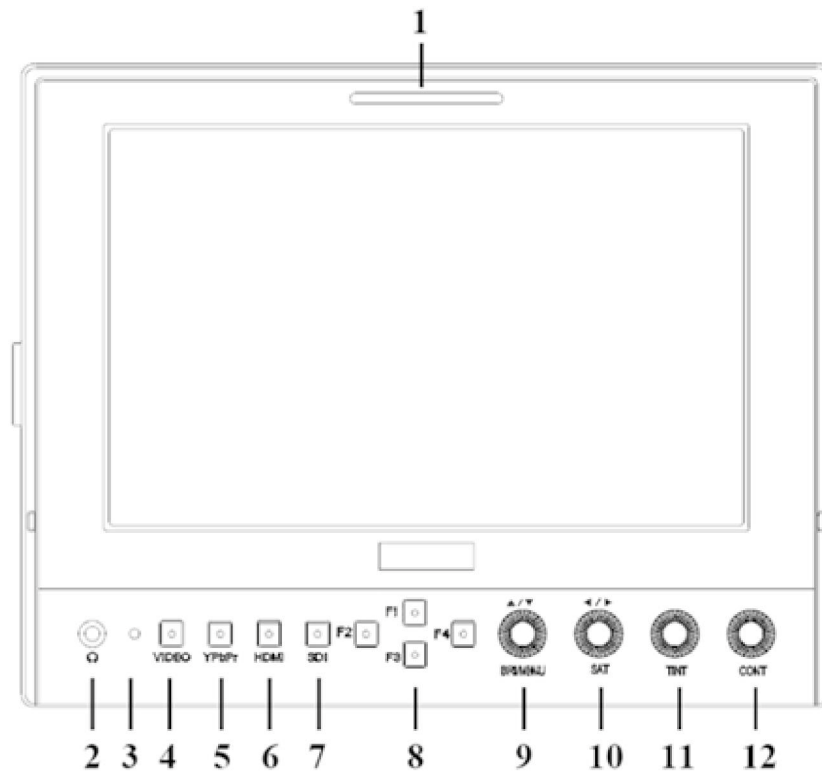

1. TALLY (indicator light).
2. Earphone jack.
3. Power indicator light: ON/OFF (Light turns to red when power on).
4. VIDEO: Indicator lights up when signal switch to video state.
5. YPbPr: Indicator lights up when signal switch to YPbPr state.
6. HDMI: Indicator lights up when signal switch to HDMI state.
7. SDI: Indicator lights up when signal switch to SDI state (optional).
8. F1、 F2、 F3、 F4:User-definable buttons.
Default functions:

F1 Camera	F3 Check Field
F2 H/V Delay	F4 Center Marker

* F1 Peaking

F3 Exposure

F2 False Color

F4 Histogram

(function customized to meet your needs)

9. Knob BRI/MENU: Press the knob to access the menu function, pressing the knob in the menu to return to the previous page or exit the menu. Rotate knob to select an option.
Default as Brightness function.
10. Knob SAT: Press the knob to select main MENU options; rotate knob to confirm the selection and adjust parameter values.
Default as Saturation function.
11. Knob TINT: Default as Tint function.
12. Knob CONT: Default as Contrast function.

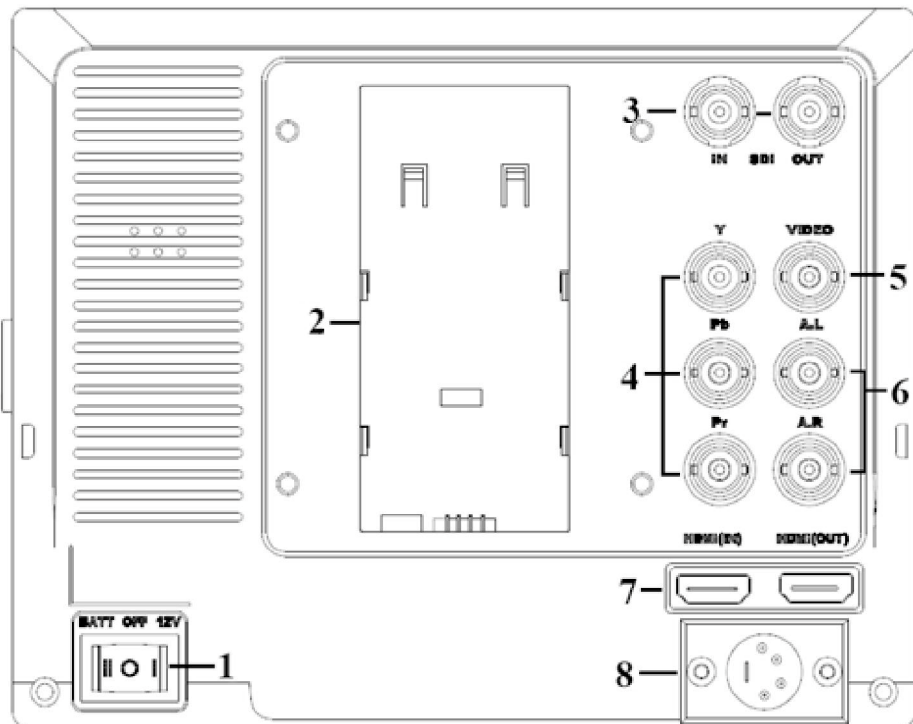

1. Battery power on/off switch: “” is battery power; “O” is power off; “I” is DC power.
2. Battery pinch slots.

3. SDI signal input / output interface (optional).
4. YPbPr signal input interface.
5. Audio signal input.
6. Audio (L/R) input.
7. HDMI (High Definition Multimedia Interface) signal input / output.
8. 4-pin XLR DC power input.

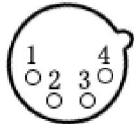
	Pin number	Signal
		GND
		Red Light
		Green Light
		+12V

INSTALLATION OF SUNSHADE COVER AND BATTERY PLATE

Installation of sunshade cover:

- ① As shown, buckle the sunshade cover on the device.
- ② As shown, cover buttoned into the appropriate slot, and fastened in accordance with the order of the both sides.



As shown, bend sunshade panel to meet and paste with sunshade cover interlocking.
Installation completed.



DV BATTERY MOUNT PLATE:

Standard mounts process

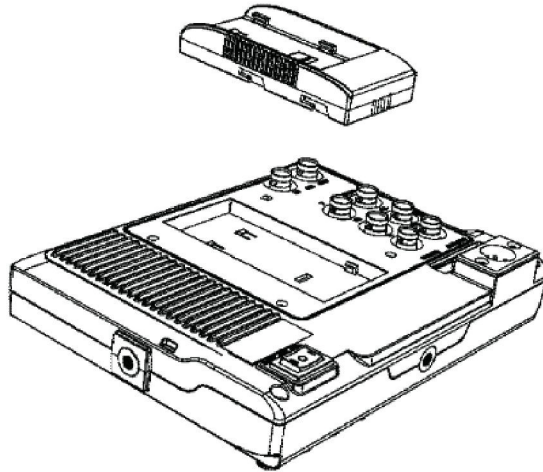

Following three types of battery plates are suitable for this device, model F970, QM91D, DU21 & LP-E6 (choose 2 out of 4).

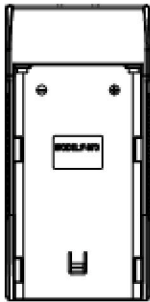

MODEL: F-970

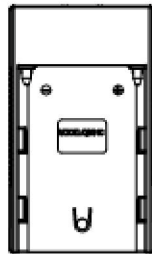

MODEL: QM91D

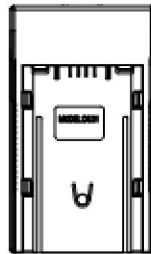

MODEL: DU21

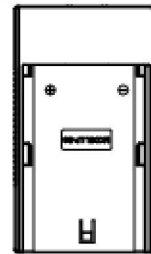

MODEL: LP-E6

DV Battery Mount Plate:

DV Battery Mount Plate Specification:

Model DU21 for battery of Panasonic DV:
NV-GS/PV-GS/DZ-MV/GS/H28/H258/H288GK series, comply with
Panasonic battery DU06/VBD140/SANYO DZhs301sw/Hitachi
DZ-HS303SW/BZ-BP14S/DZ3200/BP07W.

Model QM91D for battery of SONY DV:
DSCR1/F/S/MVCCD/E/HC15E/HC1E/AE1u/DCRTRV828/E/CCD-TRV116/
DCR-DVD/PS105K/300K/10P/1E series.

Model F970 for battery of SONY DV:
DCR-TRV series, DCR-TRV E series, VX2100E PD P series, GV-A700,
GV-D800 FD/CCD-SC/TR3/FX1E/HVR-AIC, HDR-FX1000E, HVR-Z1C,
HVR-V1C, FX7E F330.

Model LP-E6 for battery of Canon DSLR:
5D Mark II/EOS7D/EOS60D;

V-mount battery plate (optional): Please refer to GP-L130AB type battery specifications.

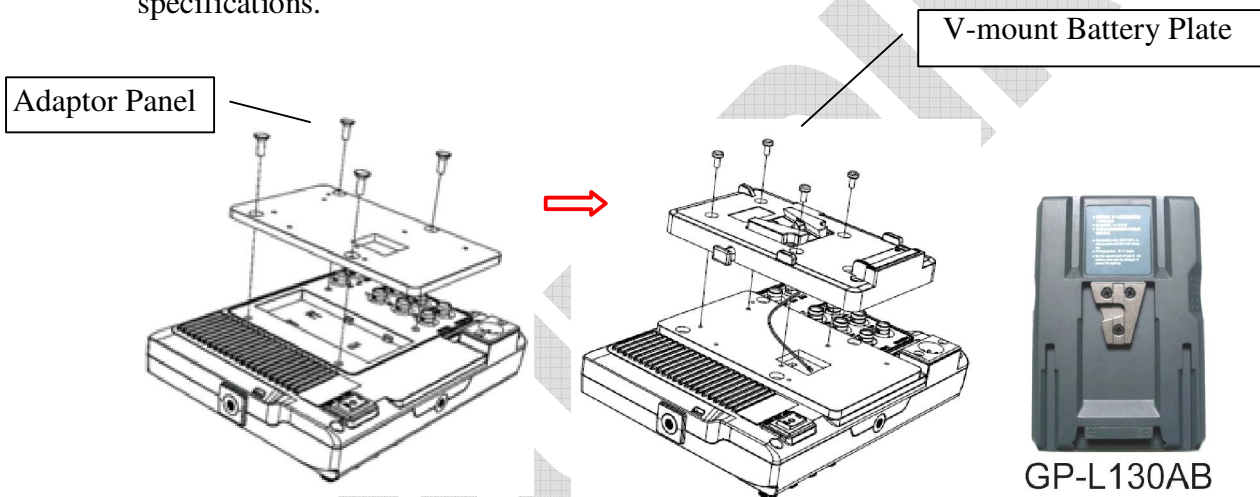

Anton Bauer mount battery plate (optional): Please refer to
GP-L130B type battery specifications.

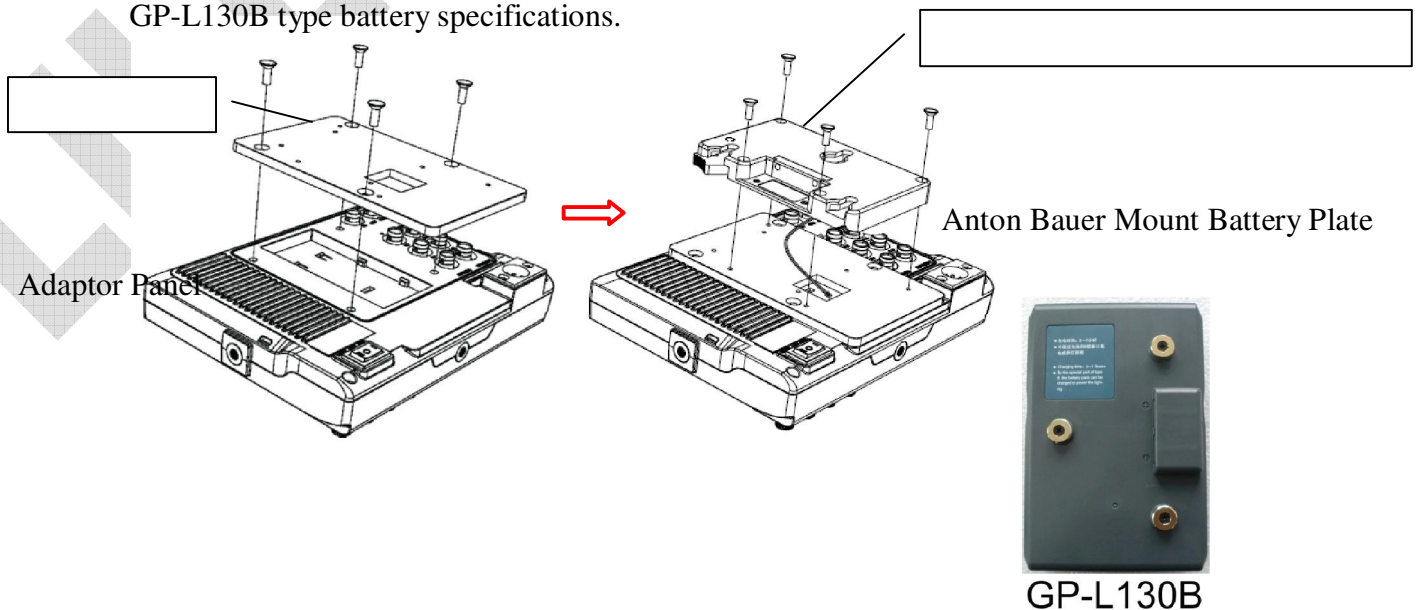

WIRING INSTRUCTIONS

Power & TALLY cable

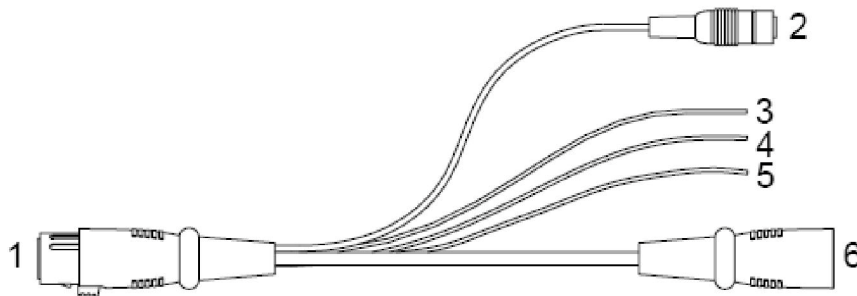

1. XLR (M) connector: to connect the XLR connector on device.
2. DC Power adapter connector.
3. Red: for TALLY red light connector.
4. Green: for TALLY green light connector.
5. Black: for grounding.
6. XLR (F) connector: for the XLR adapter.

SETTING MENU

Before setting the functions, please make sure the device is connected correctly.

When power on, press BRI/MENU knob on the device, function menus will pop-up on the screen. After confirm the option value, then press BRI/MENU knob to return to the previous, and press the BRI/MENU knob again to exit the menu settings.

BRI / MENU knob: to select an option.

SAT knob to select the main menu, adjusting option values and confirm the selection.

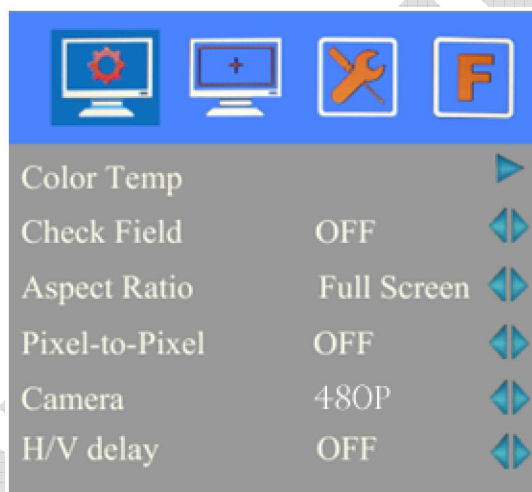

Color Temp

Settings: User, 6500°K, 7500 °K, 9300 °K.

Default: User

On User mode, user can adjust RGB gain and bias. User mode is recommended for professional users only.

Check Field

Settings: Off, Mono, Red, Green, Blue

Default: Off

Setting Mono, Red, Green or Blue display color.

Aspect Ratio

Default: 4:3

Setting screen aspect ratio: 4:3, 16:9 and full screen.

Pixel-to-Pixel

Setting: On, Off

Default: Off

Shows the original picture with 1:1 pixel mapping, if the picture is larger than the monitor's LCD resolution, the center part of the picture is shown.

Camera

Settings: 480P, 1080I

Default: 480P

For 480P screen pixel DSLR camera, such as Canon 5D II camera

For 1080I screen pixel DSLR camera, such as Canon 5D III camera

H/V delay

Settings: Off, H&V delay, V delay, H delay.

Default: Off

H/V Delay allows you to check the outside signal of active picture area. This mode is for broadcast professionals.

Underscan

Settings: On, Off

Default: Off

HDMI monitor can not display the best resolution pixel-to-pixel mode, the output resolution is smaller than the display resolution, the display will appear black side of this situation is called HDMI underscan; Conversely, the display You can not display the entire contents of the image that HDMI overscan. Underscan / overscan principle each pixel point average tensile or compression so that the image can be completely displayed on the screen.

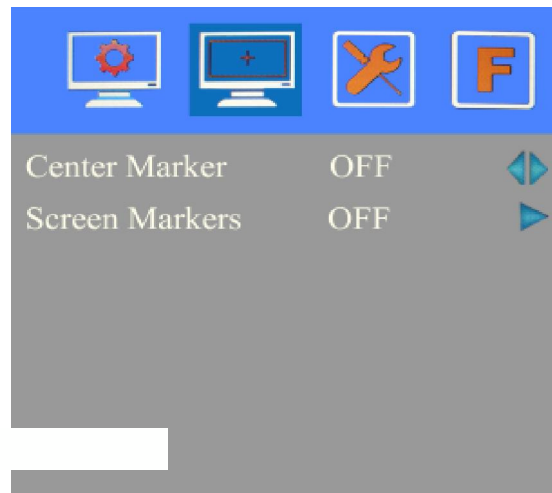

Center Marker

Settings: On, Off

Default: Off

Set to display center marker or not.

Screen Markers

Settings: Off, 95%, 93%, 90%, 88%, 85%, 80%

Default: Off

The box -shaped mark display on or off can be set in accordance with the desired ratio.

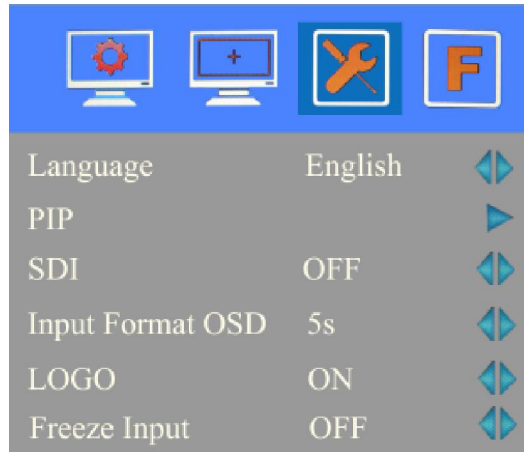

Language

Settings: English, Chinese

Default: English

Set English/ Chinese switch.

PIP

Settings: Small, Medium, Large, PBP, POP

Default: Small

PIP top life of the display default, Set small, medium, large screen in screen, as well as painting outside source adjustments and interchangeable , the small screen , screen and big screen , you can also adjust the display position , respectively, for the upper left , upper right , lower left and lower right.

Shortcut key of PIP function will be available after setting in the menu.

SDI

Settings: On, Off

Default: Off

Connect 3G-SDI signal can be set to turn on or off .

Input Format OSD

Settings: 5s, 10s, 15s

Default: 5s

The menu signal display period , display the length of time can be set according to individual needs.

LOGO

Settings: On, Off

Default: Off

Boot LOGO settings.

Freeze Input

Settings: On, Off

Default: Off

Flip H

Settings: On, Off

Default: Off

As like a mirror, the effect of an interface Flip Horizontal displayed locked.

Flip V

Settings: On, Off

Default: Off

As like a mirror, the effect of an interface Flip Vertical displayed locked.

*Peaking

Settings: Mono, Color

Default: Mono

Adjust Mono or Color.

Assistant Func.

Settings: Manual, Auto

Default: Auto

Auxiliary functions automatically. Automatically set to adjust the brightness , contrast and hue corresponding menu function can also be set manually.

Manufacturer Default

Settings: OK, Cancel

Default: Cancel

When on the picture shows size error, “Manufacturer default” operation of the equipment, which restore the factory settings, the previous record on the device no default to factory settings. Reverse the SAT / ADJ knob to select "OK".

ISP

For program upgrades, Please reboot your computer if press accidentally.

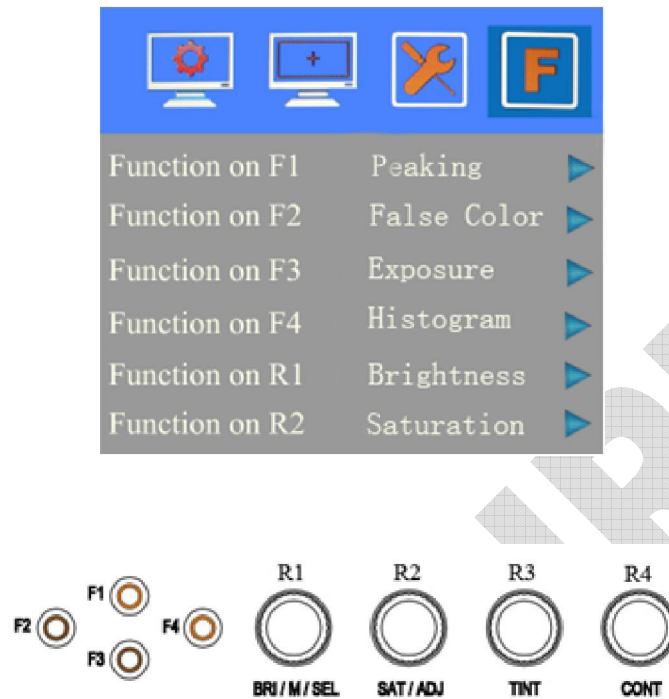

Function of buttons and knobs can be customized by users' needs.

Functions of F1-F4 buttons can also be customized: Center Marker, Screen Marker, Check Field, Color Bar, Camera, PIP, Flip, Zoom, Pixel-to-Pixel, Freeze Input, Underscan, H/V delay, Peaking, False Color, Exposure and Histogram.

Functions of R1-R4 buttons can also be customized: Contrast, Brightness, Saturation, Tint, Volume, Sharpness and Back Light.

F1-F4 or R1-R4 shortcut key steps:

1. Press BRI/MENU knob to pop up the menu;
2. Rotating SAT knob, select the  option;
3. Rotating BRI / MENU knob, select option needs to set for the F1-F4 or R1 - R4;
4. Right rotating the SAT knob to the next menu options;
5. Rotating BRI / MENU knob to select the option to be set, then turn the SAT knob right to confirm the option as default;
6. Finally, press the BRI / MENU knob to exit the menu.

Long keep press any F1-F4 button to pop-up shortcut menu when screen without a menu. As follows (item selected default as blue font):

Option can be selected by rotating BRI / MENU knob.

Finally, right turn the SAT knob to set the option as default.

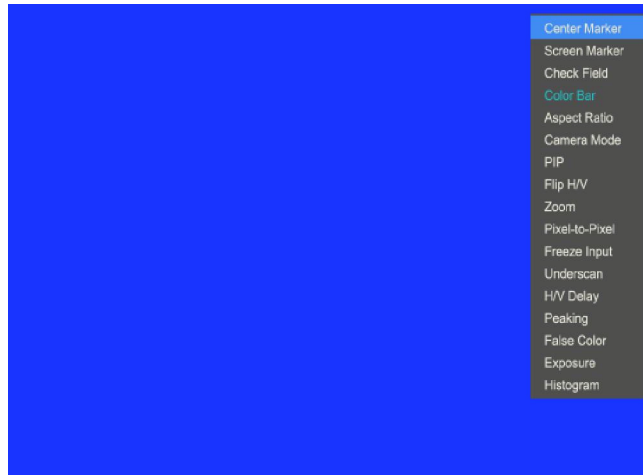

ACCESSORIES:

Standard Accessories:



1. Sun Shade Cover		1 Piece
2. Battery Plate (F-970/QM91D/DU21/LP-E6)		2 Pieces (Choose 2 out of 4)
3. HDMI A/C cable		1 Piece
4. Power & TALLY cable		1 Piece
5. Shoe Mount (for camera only)		1 Piece
6. 12V DC adapter	Piece	1
7. Suitcase	Piece	1
8. Adaptor Panel	Piece	1
9. Manual	Copy	1

Optional Accessories



1. Anton Bauer Mount Battery Plate
1Piece
2. V-mount Battery Plate
1Piece
3. Li-ion Battery
1Piece

PARAMETERS:

Panel Size	7" LED backlit
Resolution	1280×800
Brightness	400cd/m ²
Contrast	800:1
Viewing Angle	178°/ 178°(H/V)
Input Voltage	DC12V (XLR DC Connection)
Input Signal	HDMI, YPbPr, AV and 3G-SDI(optional),
Current	900mA
Power Consumption	≤11W
Size:(LWD)	191.5×152×31mm/141mm (with cover)
Weight	760g / 938g (with cover) / 2160g (with suitcase)

TROUBLE SHOOTING

1. Only black-and-white display:

Check whether the color saturation is properly setup.

2. Power on but no pictures:

Check whether the cables of Video, HDMI, YPbPr and SDI are correctly connected. Please use the standard power adapter coming with the product package. Improper power input may cause the device.

3. Wrong or abnormal colors:

Check whether the cables are correctly and properly connected. Broken or loose pins of the cables may cause a bad connection.

4. When on the picture shows size error:

Press “BRI/MENU” →  → “Underscan” to zoom in/out pictures automatically
When receiving HDMI signals.

5. Other problems:

Please press “BRI/MENU” button and choose “ → Manufacturer Default → OK”

6. According to the ISP, the machine can not function properly:

ISP for program upgrades, non-professionals do not use. Please reboot your computer if press accidentally!

* It is normal to see some bright lines appear on the screen when turn off the device.

Note: due to constant effort to improve products and product features, specifications may change without notice.